

Data Sheet

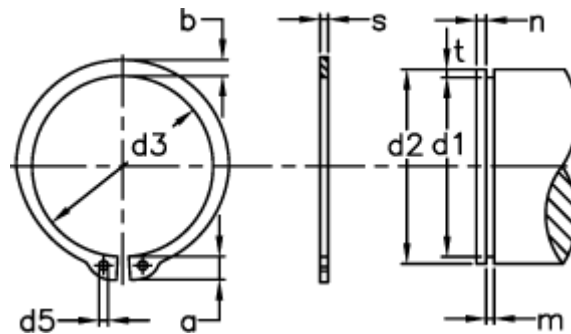

Article number: 0109093
 Description: Retaining ring AS 90x4.0
 Spring steel
 Note: Fitted with ZGA pliers

Measures



a max	= 10.2	Description	= AS 90	s	= 4.00
AN mm ²	= 485.0	FN kN	= 80.80	t	= 1.75
B	= 1.78	FRg kN	= 61.0	tol	= -0.35
b	= 8.2	FR kN	= 386.0	tol	= -0.10
d1	= 86.5	g	= 3.0	tol	= +0,54 -1,30
d2	= 90	m min	= 4.15	Tong	= ZGA-4
d3	= 84.5	n abl x 1000	= 5	Weight kg/1000	= 55.60
d5 min	= 3.5	Nominal drive	= 5.3		